

Article number: 12717000080120

Description: KLEE-coil 717 000 080.120

M8 Unhardened, zinc-pl. & chr. yellow

Measures

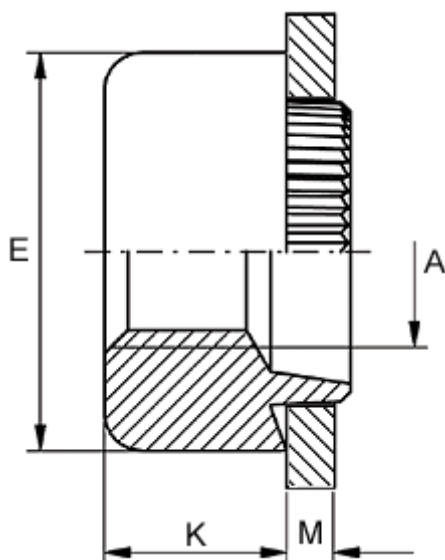

Female thread A	= M8
Height K	= 6.0
Outer diameter E	= 16.0
Plate thickness	= 4.7 to 4.9
Recommended bore diameter for extreme load	= 13.0
Recommended bore diameter for normal use	= 13.0